

USER MANUAL

COMBI



SAFETY INFORMATION

Please read the operating and installation instructions carefully!

They contain important information on how to install, use and maintain the appliance.

The manufacturer is not liable if you fail to comply with the instructions and warnings.

Retain all documents for subsequent use or for the next owner.

- **Do not connect the appliance to the electricity supply until all packing and transit protectors have been removed. Keep children away from packaging and its parts.**
- **Danger of suffocation from folding cartons and plastic film!**
- **Leave to stand for at least 4 hours before switching on the**

product, to allow compressor oil to settle if transported horizontally.

- **Make sure there is no transport damage.**
- **Do not damage the refrigerant circuit.**
- **Maintain the ventilation openings in the appliance enclosure or in the built-in structure, free of obstruction.**
- **Never use water to wash the compressor position, wipe it with a dry cloth thoroughly after cleaning to prevent rust.**
- **Handle the appliance always with at least two persons because it is heavy.**

- Install and level the appliance in an area suitable for its size and use.
- Make sure that the electrical information on the rating plate agrees with the power supply. If it does not, contact an electrician.
- The appliance is operated by a 220-240 VAC/50 Hz power supply. Abnormal voltage fluctuation may cause the appliance to fail to start, or damage to the temperature control or compressor, or there may be an abnormal noise when operating. In such case, an automatic regulator shall be mounted.
- Only for UK:
The appliance's power cable is fitted with 3-cord (grounding) plug that fits a standard 3-cord (grounded) socket. Never cut off or dismount the third pin (grounding). After the appliance is installed, the plug should be accessible.
- Make sure that mains cable is not caught under the appliance during and after carrying/moving the appliance, to avoid the mains cable becoming cut or damaged. If the supply cord is damaged, it must be replaced by the manufacturer, its service agent or similarly qualified person in order to avoid a hazard.

- **Do not install the appliance in humid, oily or dusty places, nor expose it to direct sunlight and to water.**
- **Do not install the appliance near heaters or inflammable materials.**
- **FOR appliances with a freezer compartment: if there is a power failure do not open the lid. Frozen food should not be affected if the failure lasts for less than the hours indicated on the rating label (Temperature rise time). If the failure is longer, then the food should be checked and eaten immediately or cooked and then refrozen.**

- If you find that the lid of the appliance is difficult to open just after you have closed it, don't worry. This is due to the pressure difference which will equalize and allow the lid to be opened normally after a few minutes.
- Do not store medicines, bacteria or chemical agents in the appliance. This appliance is a household appliance, it is not recommended to store materials that require strict temperatures.
- Do not excessively pull or fold the power cord or touch the plug with wet hands.
- Do not store products which contain flammable propellant (e.g. spray cans) or explosive substances in the appliance. Risk of explosion!
- Do not place unstable articles (heavy objects, containers filled with water) on top of the refrigerator, to avoid personal injury caused by falling or electric shock caused by contact with water.

- Do not use electrical appliances inside the food storage compartments, unless they are of the type recommended by the manufacturer.
- Do not touch internal cooling elements, especially with wet hands, to avoid cracks or injuries.
- At risk here are children, people who have limited physical, mental or sensory abilities, as well as people who have inadequate knowledge concerning safe operation of the appliance.
- Check that children and vulnerable people have understood the hazards. A person responsible for safety must supervise or instruct children and vulnerable people

who are using the appliance. Only children aged 8 years and above may use the appliance.

- Children should not play with the appliance.
- Children aged from 3 to 8 years are allowed to load and unload this appliance.
- FOR appliances with a freezer compartment: do not store bottled or canned liquids (especially carbonated drinks) in the freezer compartment. Bottles and cans may burst!
- FOR appliances with a freezer compartment: never put frozen food straight from the freezer compartment in your mouth. Risk of low-temperature burns!
- Keep plastic parts and the door seal free of oil and grease. Otherwise, plastic parts and the door seal will become porous.
- Before performing any operation, unplug the power cord from the power socket.
- Do not use mechanical devices or other means to accelerate the defrosting process, other than those recommended by the manufacturer.

- Do not use pointed or sharp-edged objects such as knives or forks to remove the frost.
- Never use hairdryers, electrical heaters or other such electrical appliances for defrosting.
- It is recommended to keep the plug clean, any excessive dust residues on the plug can be the cause fire.
- Do not try to repair, disassemble or modify the appliance by yourself. In case of repair please contact always our customer service.
- Supervise children while the appliance is being cleaned or maintained.
- Do not clean the cold glass shelves with hot water. Sudden temperature change may cause the glass to break.
- **WARNING:** The tubes of the refrigeration circuit convey a small quantity of an environmentally friendly but flammable refrigerant (R600a) and insulating gas (cyclopentane). It does not damage the ozone layer and does not increase the greenhouse effect. If refrigerant escapes, it may injure your eyes or ignite.
 - If the refrigerant

circuit should be damaged:

- Switch off the appliance and pull out the mains plug,
- Keep naked flames and/or ignition sources away from the appliance,
- Thoroughly ventilate the room for several minutes,
- Inform customer service.
- **WARNING:** Do not damage the plug and/or the power cord; this could cause electrical shocks or fires.
- **WARNING:** Do not use multiple portable socket-outlets or portable power supplies. We do not recommend the use of extension leads and multi-way adapters.
- Do not attempt to sit or stand on the top of the appliance. You could injure yourself or damage it. This appliance is not designed for stacking with any other ones.
- The product is designed and built for domestic household use only.
- Only original parts supplied by the manufacturer may be used. The manufacturer guarantees that only these parts satisfy the safety requirements.
- Opening the door for long periods can cause a significant

increase of the temperature in the compartments of the appliance.

- Clean regularly surfaces that can come in contact with food and accessible drainage systems.
- Clean water tanks if they have not been used for 48h; flush the water system connected to a water supply if water has not been drawn for 5 days.
- Store raw meat and fish in suitable containers in the refrigerator, so that it is not in contact with or drip onto other food.
- Two-star frozen-food compartments(if they are presented in the appliance) are suitable for storing

pre- frozen food, storing or making ice-cream and making ice cubes.

- One-, two- and three -star compartments, if present in the appliance, are not suitable for the freezing of fresh food.
- If the appliance is left empty for long periods, switch off, defrost, clean, dry and leave the door open to prevent mould developing within the appliance.
- FOR Wine Coolers: this appliance is intended to be used exclusively for the storage of wine

- **FOR a free standing appliance: this refrigerating appliance is not intended to be used as a built-in appliance**
- **FOR appliances without a 4-star compartment: this refrigerating appliance is not suitable for freezing food stuffs.**

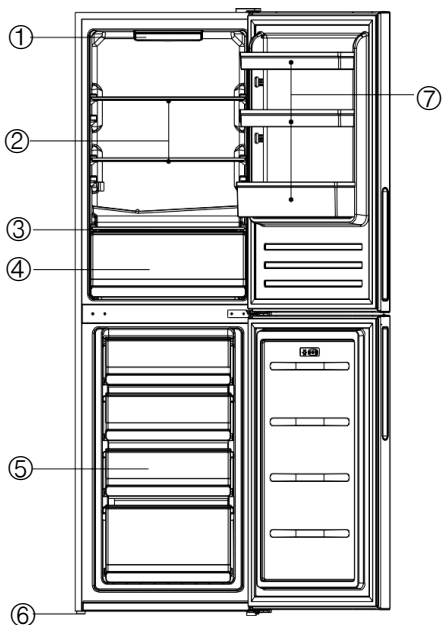

TRF-39LEA	
No.	Description
①	Electronic control board
②	Glass shelf
③	Crisper Cover
④	Crisper
⑤	Freezer drawer
⑥	Adjustable feet
⑦	Door balcony

FOR appliances without a 4-star compartment: this refrigerating appliance is not suitable for freezing foodstuffs

FOR a free standing appliance: this refrigerating appliance is not intended to be used as a built-in appliance

FOR Wine Coolers: this appliance is intended to be used exclusively for the storage of wine

POSITIONING

Install the appliance at a location where the ambient temperature corresponds to the climate class indicated on the rating plate of the appliance:

- Extended temperate (SN): 'this refrigerating appliance is intended to be used at ambient temperatures ranging from 10 °C to 32 °C'
- Temperate (N): 'this refrigerating appliance is intended to be used at ambient temperatures ranging from 16 °C to 32 °C'
- Subtropical (ST): 'this refrigerating appliance is intended to be used at ambient temperatures ranging from 16 °C to 38 °C'
- Tropical (T): 'this refrigerating appliance is intended to be used at ambient temperatures ranging from 16 °C to 43 °C'

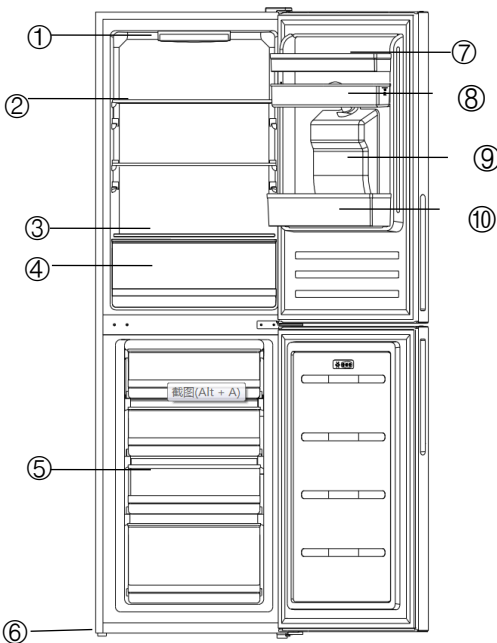

TRF-39LWE	
No.	Description
①	Electronic control board
②	Glass shelf
③	Crisper Cover
④	Crisper
⑤	Freezer drawer
⑥	Adjustable feet
⑦	Upper Door balcony
⑧	Water tank
⑨	Water dispenser main part
⑩	Lower balcony

FOR appliances without a 4-star compartment: this refrigerating appliance is not suitable for freezing foodstuffs

FOR a free standing appliance: this refrigerating appliance is not intended to be used as a built-in appliance

FOR Wine Coolers: this appliance is intended to be used exclusively for the storage of wine

POSITIONING

Install the appliance at a location where the ambient temperature corresponds to the climate class indicated on the rating plate of the appliance:

- Extended temperate (SN): 'this refrigerating appliance is intended to be used at ambient temperatures ranging from 10 °C to 32 °C'
- Temperate (N): 'this refrigerating appliance is intended to be used at ambient temperatures ranging from 16 °C to 32 °C'
- Subtropical (ST): 'this refrigerating appliance is intended to be used at ambient temperatures ranging from 16 °C to 38 °C'
- Tropical (T): 'this refrigerating appliance is intended to be used at ambient temperatures ranging from 16 °C to 43 °C'

FOOD STORAGE

Position different food in different compartments according to be below table

Refrigerator compartment	Type of food
Door or balconies of fridge compartment	<ul style="list-style-type: none"> Foods with natural preservatives, such as jams, juices, drinks, condiments. Do not store perishable foods
Crisper drawers (salad drawer)	<ul style="list-style-type: none"> Fruits, herbs and vegetables should be placed

	<p>separately in the crisper</p> <p>Do not store bananas, onions, potatoes, garlic in the refrigerator</p>
Fridge shelf – middle	<ul style="list-style-type: none"> Dairy products, eggs
Fridge shelf – top	<ul style="list-style-type: none"> Foods that do not need cooking, such as ready-to-eat foods, deli meats, leftovers.
Freezer drawer(s)/tray	<ul style="list-style-type: none"> Foods for long-term storage Bottom drawer for raw meat, poultry, fish Middle drawer for frozen vegetables, chips. Top tray for ice cream, frozen fruit, frozen baked goods.

- For most food categories, the longest storage time in the fridge compartment is achieved with colder temperatures. Since some particular products (as fresh fruits and vegetables) may be damaged with colder temperatures, it is suggested to keep them in the crisper drawers, whenever present. If not present, maintain an average

setting of the thermostat.

- It's suggested to set the temperature at 4°C in the fridge compartment, and, whenever possible, at -18°C in the freezer compartment.
- For frozen food, refer to the storage time written on the food packaging. This storage time is achieved whenever the setting respects the reference temperatures of the compartment (one-star -6°C, two stars -12°C, three stars -18°

approximate fridge temperature .

TECHNICAL ASSISTANCE

To contact the technical assistance, visit our website: <https://corporate.haier-europe.com/en/>

Under the section “website”, choose the brand of your product and your country. You will be redirected to the specific website where you can find the telephone number and form to contact the technical assistance

For further information about the product, please consult <https://eprel.ec.europa.eu/> or scan the QR on the energy label supplied with the appliance



The above image is the control panel, and only the buttons on left and right are functional to control the refrigerator. The left button is to switch on/off the refrigerator, while the right button is to adjust the temperature.

 Press this button for 3 seconds to switch the appliance on or off.



This product has power-off or power failure memory function.

 This button is used to adjust the temperature within the fridge. Press this sensor to make adjustment, the number starts to flash, and if the button stops, the lit number flashes , after 5 seconds stop flashing , and the temperature shift corresponding to the number is confirmed, and then as many times as necessary until the desired level is selected. The settings range from super cooling, 2°C, 3°C, 4°C, 6°C, 8°C, and it will represents the

Start super cooling: when super cooling selected, it means refrigerator will work at 2°C for 24 hours, after that, the function will quit automatically, then back to the original temperature setting.

Position	Conditions
2&3	Summer or ambient temperature between 25-35 °C
4	Spring, autumn or ambient temperature between 15-25 °C
6&8	Winter, or ambient temperature between 5-15 °C

Please note: Where possible, avoid having the temperature setting on super cooling or 2°C all of the time. This will help to alleviate strain on the compressor and refrigeration system.

Press the  for 15s,  key flickering, then access to the laboratory adjustable state

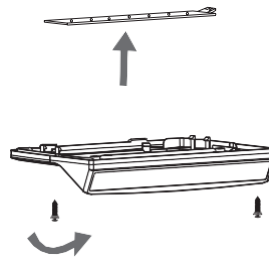

The lamp replacement operation

instructions are as follows:

Replace the lights

(lamp parameter: 12V/5W)

1, to unplug the power plug.

2, Remove the top lamp cover with a screwdriver.

3, Remove the lampshade and replace

4, returns the top hood in turn

1. Make sure that the refrigerator is unplugged, pry the hinge cover up and off , remove four screws that secure the upper hinge to the door and remove the hinge, then remove the fridge door.

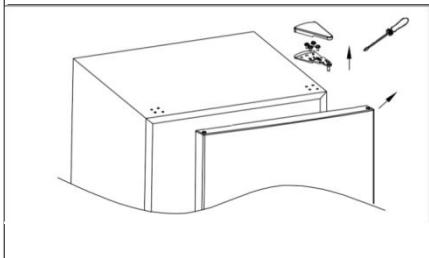

2. Remove two screws that secure the center hinge.

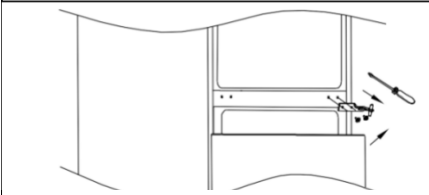

3. Remove the screws that secure the lower hinge to the right side of the cabinet, then the hinge and adjustable feet.

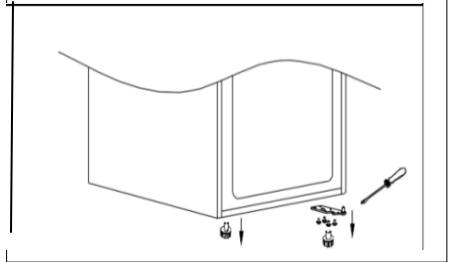

4. Remove the right door stopper on the bottom of fridge and freezer door, then get the left door stopper from the accessory bag, install it on the bottom left side of fridge door and freezer door. Remove the pin shaft and install to other side.

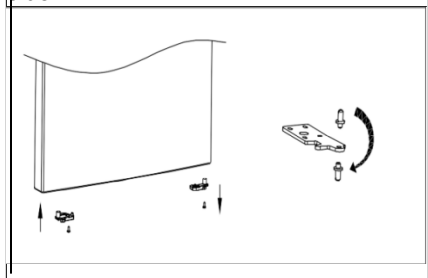

5. Remove the freezer right hinge hole cover, install to left side. Remove the center hinge screw hole plug on the left side, then install its to right side,

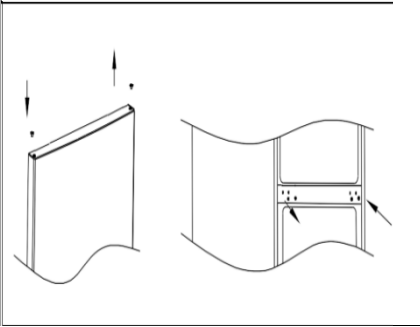

6. Install the bottom hinge to the left side of cabinet, then install two adjustable feet on the current position, then install the freezer door.

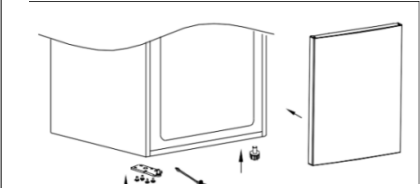

8. Remove the left hinge hole cover to right side, then install the upper hinge and hinge cover on the left side of cabinet.

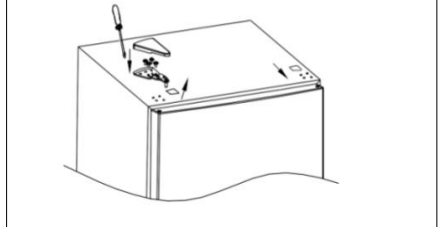

7. Install the center hinge to the left side, then install the fridge door at the same time.

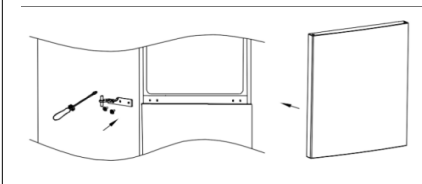

Tips for Water dispenser

The refrigerator includes a water dispenser which makes it easier to fill your cup of water and have access to cold water almost immediately. The water dispenser includes one tank of **2.0 litres** of water which has to be filled out. To use water dispenser follow the instructions below:

1. Open the refrigerator door to take out the water tank from the door.
2. Open the filter cover of the water tank, slowly fill the water tank to prevent any spills until the tank is filled. Then close the filler cover of the water tank. Then put back the tank at the original place. See below picture

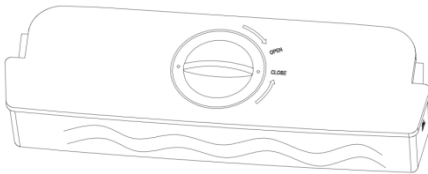

3. Once the water tank is full, set the thermostat at the lowest mode or the Fast Cool mode, and one hour later you can

dispense water for drinking. See image below picture. Please restore to the original temperature setting after use.

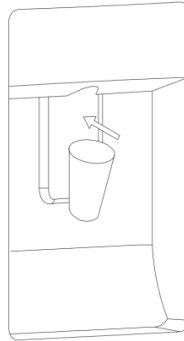

1. Make sure that the refrigerator is unplugged, pry the hinge cover up and off, remove four screws that secure the upper hinge to the door and remove the hinge, then remove the fridge door.

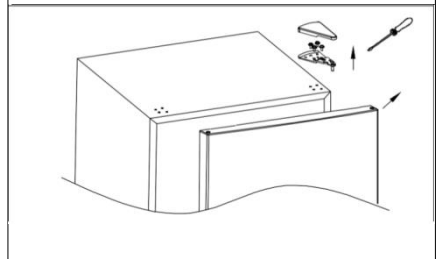

2. Remove two screws that secure the center hinge.

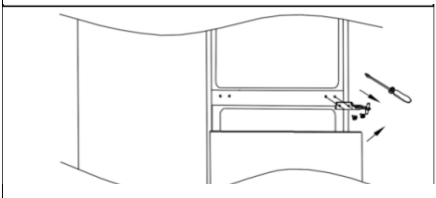

3. Remove the screws that secure the lower hinge to the right side of the cabinet, then the hinge and adjustable feet.

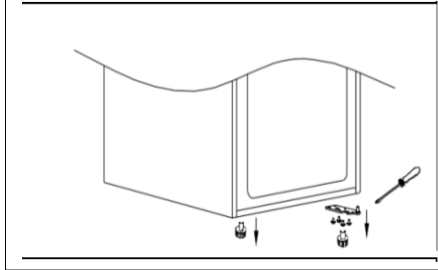

4. Remove the right door stopper on the bottom of fridge and freezer door, then get the left door stopper from the accessory bag, install it on the bottom left side of fridge door and freezer door. Remove the pin shaft and install to other side.

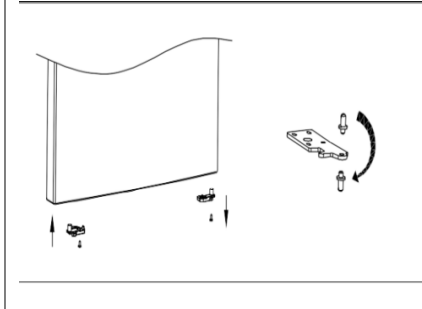

5. Remove the freezer right hinge hole cover, install to left side. Remove the center hinge screw hole plug on the left side, then install its to right side,

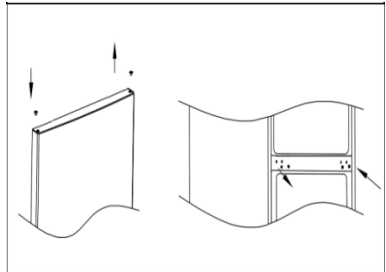

6. Install the bottom hinge to the left side of cabinet, then install two adjustable feet on the current position, then install the freezer door.

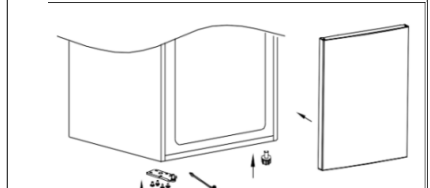

7. Install the center hinge to the left side, then install the fridge door at the same time.

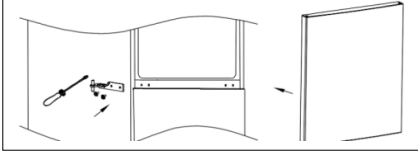

8. Remove the left hinge hole cover to right side, then install the upper hinge and hinge cover on the left side of cabinet.

